

# BLC10G18XS-600AVT

Power LDMOS transistor

Rev. 1 — 7 May 2020

AMPLEON

Product data sheet

## 1. Product profile

### 1.1 General description

600 W LDMOS packaged asymmetric Doherty power transistor for base station applications at frequencies from 1805 MHz to 1880 MHz.

**Table 1. Typical performance**

Typical RF performance at  $T_{case} = 25\text{ °C}$  in an asymmetrical Doherty production test circuit.

$V_{DS} = 30\text{ V}$ ;  $I_{Dq} = 800\text{ mA}$  (main);  $V_{GS(amp)peak} = 1.2\text{ V}$ , unless otherwise specified.

Test signal	f	$V_{DS}$	$P_{L(AV)}$	$G_p$	$\eta_D$	ACPR
	(MHz)	(V)	(W)	(dB)	(%)	(dBc)
1-carrier W-CDMA	1805 to 1880	30	115	15.5	49	-33.7 <a href="#">[1]</a>

[1] Test signal: 1-carrier W-CDMA; 3GPP test model 1; 64 DPCH; PAR = 9.9 dB at 0.01 % probability on CCDF.

### 1.2 Features and benefits

- Excellent ruggedness
- High efficiency
- Low thermal resistance providing excellent thermal stability
- Lower output capacitance for improved performance in Doherty applications
- Designed for low memory effects providing excellent digital pre-distortion capability
- Internally matched for ease of use
- Integrated ESD protection
- For RoHS compliance see the product details on the Ampleon website

### 1.3 Applications

- RF power amplifiers for base stations and multi carrier applications in the 1805 MHz to 1880 MHz frequency range

## 2. Pinning information

Table 2. Pinning

Pin	Description	Simplified outline	Graphic symbol
1	drain (peak)		
2	drain (main)		
3	gate (main)		
4	gate (peak)		
5	source <a href="#">[1]</a>		
6	video decoupling (peak)		
7	video decoupling (main)		

[1] Connected to flange.

## 3. Ordering information

Table 3. Ordering information

Type number	Package		
	Name	Description	Version
BLC10G18XS-600AVT	-	air cavity plastic earless flanged package; 6 leads	SOT1258-4

## 4. Limiting values

Table 4. Limiting values

In accordance with the Absolute Maximum Rating System (IEC 60134).

Symbol	Parameter	Conditions	Min	Max	Unit
$V_{DS}$	drain-source voltage		-	65	V
$V_{GS(amp)main}$	main amplifier gate-source voltage		-6	+9	V
$V_{GS(amp)peak}$	peak amplifier gate-source voltage		-6	+9	V
$T_{stg}$	storage temperature		-65	+150	°C
$T_j$	junction temperature		<a href="#">[1]</a>	225	°C
$T_{case}$	case temperature	operating	<a href="#">[1]</a>	+125	°C

[1] Continuous use at maximum temperature will affect the reliability, for details refer to the online MTF calculator.

## 5. Thermal characteristics

Table 5. Thermal characteristics

Symbol	Parameter	Conditions	Typ	Unit
$R_{th(j-c)}$	thermal resistance from junction to case	$V_{DS} = 30\text{ V}; I_{Dq} = 800\text{ mA (main)};$ $V_{GS(amp)peak} = 1.2\text{ V}; T_{case} = 80\text{ °C}$		
		$P_L = 115\text{ W}$	0.18	K/W
		$P_L = 141\text{ W}$	0.16	K/W

## 6. Characteristics

**Table 6. DC characteristics**

$T_j = 25\text{ °C}$  unless otherwise specified.

Symbol	Parameter	Conditions	Min	Typ	Max	Unit
<b>Main device</b>						
$V_{(BR)DSS}$	drain-source breakdown voltage	$V_{GS} = 0\text{ V}; I_D = 2.1\text{ mA}$	65	-	-	V
$V_{GS(th)}$	gate-source threshold voltage	$V_{DS} = 10\text{ V}; I_D = 208\text{ mA}$	1.6	2.0	2.4	V
$V_{GSq}$	gate-source quiescent voltage	$V_{DS} = 30\text{ V}; I_D = 800\text{ mA}$	-	2.2	-	V
$I_{DSS}$	drain leakage current	$V_{GS} = 0\text{ V}; V_{DS} = 32\text{ V}$	-	-	2.8	$\mu\text{A}$
$I_{DSX}$	drain cut-off current	$V_{GS} = V_{GS(th)} + 2.37\text{ V}$	-	37	-	A
$I_{GSS}$	gate leakage current	$V_{GS} = 9\text{ V}; V_{DS} = 0\text{ V}$	-	-	280	nA
$g_{fs}$	forward transconductance	$V_{DS} = 10\text{ V}; I_D = 10.4\text{ A}$	-	20.5	-	S
$R_{DS(on)}$	drain-source on-state resistance	$V_{GS} = V_{GS(th)} + 2.37\text{ V}; I_D = 7.28\text{ A}$	-	67.1	111	$\text{m}\Omega$
<b>Peak device</b>						
$V_{(BR)DSS}$	drain-source breakdown voltage	$V_{GS} = 0\text{ V}; I_D = 4.3\text{ mA}$	65	-	-	V
$V_{GS(th)}$	gate-source threshold voltage	$V_{DS} = 10\text{ V}; I_D = 434\text{ mA}$	1.6	2.0	2.4	V
$V_{GSq}$	gate-source quiescent voltage	$V_{DS} = 30\text{ V}; I_D = 2000\text{ mA}$	-	2.2	-	V
$I_{DSS}$	drain leakage current	$V_{GS} = 0\text{ V}; V_{DS} = 32\text{ V}$	-	-	2.8	$\mu\text{A}$
$I_{DSX}$	drain cut-off current	$V_{GS} = V_{GS(th)} + 2.37\text{ V}$	-	68	-	A
$I_{GSS}$	gate leakage current	$V_{GS} = 9\text{ V}; V_{DS} = 0\text{ V}$	-	-	280	nA
$g_{fs}$	forward transconductance	$V_{DS} = 10\text{ V}; I_D = 21.7\text{ A}$	-	39	-	S
$R_{DS(on)}$	drain-source on-state resistance	$V_{GS} = V_{GS(th)} + 2.37\text{ V}; I_D = 15.2\text{ A}$	-	36.3	58.4	$\text{m}\Omega$

**Table 7. RF characteristics**

Test signal: 1-carrier W-CDMA; PAR = 9.6 dB at 0.01 % probability on the CCDF; 3GPP test model 1; 1 to 64 DPCH;  $f_1 = 1807.5\text{ MHz}; f_2 = 1877.5\text{ MHz}$ ; RF performance at  $V_{DS} = 30\text{ V}; I_{Dq} = 800\text{ mA}$  (main);  $V_{GS(amp)peak} = 1.2\text{ V}; T_{case} = 25\text{ °C}$ ; unless otherwise specified; in an asymmetrical Doherty production test circuit at frequencies from 1807.5 MHz to 1877.5 MHz.

Symbol	Parameter	Conditions	Min	Typ	Max	Unit
$G_p$	power gain	$P_{L(AV)} = 115\text{ W}$	14.2	15.4	-	dB
$RL_{in}$	input return loss	$P_{L(AV)} = 115\text{ W}$	-	-14	-9	dB
$\eta_D$	drain efficiency	$P_{L(AV)} = 115\text{ W}$	43	48	-	%
ACPR	adjacent channel power ratio	$P_{L(AV)} = 115\text{ W}$	-	-30	-25	dBc

**Table 8. RF characteristics**

Test signal: 1-carrier W-CDMA; PAR = 9.6 dB at 0.01 % probability on the CCDF; 3GPP test model 1; 1 to 64 DPCH;  $f_1 = 1807.5\text{ MHz}; f_2 = 1877.5\text{ MHz}$ ; RF performance at  $V_{DS} = 30\text{ V}; I_{Dq} = 800\text{ mA}$  (main);  $V_{GS(amp)peak} = 1.2\text{ V}; T_{case} = 25\text{ °C}$ ; unless otherwise specified; in an asymmetrical Doherty production test circuit at a frequency of 1877.5 MHz.

Symbol	Parameter	Conditions	Min	Typ	Max	Unit
$PAR_O$	output peak-to-average ratio	$P_{L(AV)} = 160\text{ W}$	5.95	6.55	-	dB
$P_{L(M)}$	peak output power	$P_{L(AV)} = 160\text{ W}$	617	720	-	W

## 7. Test information

### 7.1 Ruggedness in Doherty operation

The BLC10G18XS-600AVT is capable of withstanding a load mismatch corresponding to VSWR = 10 : 1 through all phases under the following conditions:  $V_{DS} = 30\text{ V}$ ;  $I_{Dq} = 800\text{ mA}$ ;  $V_{GS(amp)peak} = 1.2\text{ V}$ ;  $f = 1807.5\text{ MHz}$ ;  $P_L = 207\text{ W}$  (5.5 dB OBO); 100 % clipping.

### 7.2 Impedance information

**Table 9. Typical impedance of main device**

Measured load-pull data of main device;  $I_{Dq} = 1000\text{ mA}$  (main);  $V_{DS} = 28\text{ V}$ ; pulsed CW ( $t_p = 100\text{ }\mu\text{s}$ ;  $\delta = 10\%$ ).

f (MHz)	Z <sub>S</sub> [1] ( $\Omega$ )	Z <sub>L</sub> [1] ( $\Omega$ )	P <sub>L</sub> [2] (W)	$\eta_D$ [2] (%)	G <sub>p</sub> [2] (dB)
<b>Maximum power load</b>					
1805	1.9 – j4.9	1.1 – j2.7	295	58.0	15.1
1845	2.6 – j5.4	1.3 – j2.7	290	61.5	15.7
1880	3.5 – j5.8	1.2 – j2.5	285	61.0	15.9
<b>Maximum drain efficiency load</b>					
1805	2.0 – j5.2	2.6 – j1.4	180	72.8	18.0
1845	2.8 – j5.6	2.3 – j1.6	190	72.8	17.8
1880	4.2 – j5.9	2.5 – j1.3	165	72.0	18.0

[1] Z<sub>S</sub> and Z<sub>L</sub> defined in [Figure 1](#).

[2] At 3 dB gain compression.

**Table 10. Typical impedance of peak device**

Measured load-pull data of peak device;  $I_{Dq} = 2000\text{ mA}$  (peak);  $V_{DS} = 28\text{ V}$ ; pulsed CW ( $t_p = 100\text{ }\mu\text{s}$ ;  $\delta = 10\%$ ).

f (MHz)	Z <sub>S</sub> [1] ( $\Omega$ )	Z <sub>L</sub> [1] ( $\Omega$ )	P <sub>L</sub> [2] (W)	$\eta_D$ [2] (%)	G <sub>p</sub> [2] (dB)
<b>Maximum power load</b>					
1805	1.2 – j4.6	1.6 – j2.7	535	59.5	14.7
1845	1.5 – j5.1	1.4 – j2.7	530	58.5	14.6
1880	2.0 – j5.6	1.4 – j2.7	525	58.0	14.8
<b>Maximum drain efficiency load</b>					
1805	1.1 – j4.6	1.6 – j1.6	415	67.8	16.1
1845	1.4 – j5.1	1.4 – j1.5	375	66.5	16.4
1880	1.8 – j5.6	1.2 – j1.8	405	65.5	16.2

[1] Z<sub>S</sub> and Z<sub>L</sub> defined in [Figure 1](#).

[2] At 3 dB gain compression.

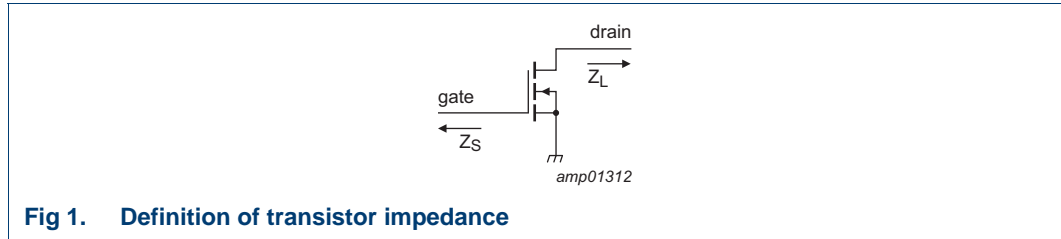

Fig 1. Definition of transistor impedance

### 7.3 Recommended impedances for Doherty design

**Table 11. Typical impedance of main at 1 : 1 load**

Measured load-pull data of main device;  $I_{Dq} = 1000 \text{ mA (main)}$ ;  $V_{DS} = 28 \text{ V}$ ; pulsed CW ( $t_p = 100 \mu\text{s}$ ;  $\delta = 10 \%$ ).

f (MHz)	$Z_S$ [1] ( $\Omega$ )	$Z_L$ [1] ( $\Omega$ )	$P_{L(3dB)}$ (W)	$\eta_D$ [2] (%)	$G_p$ [2] (dB)
1805	2.1 – j4.4	1.2 – j3.1	265	40.5	18.0
1845	2.6 – j4.7	1.2 – j2.8	265	40.5	18.2
1880	3.2 – j5.0	1.2 – j2.6	250	40.8	18.6

[1]  $Z_S$  and  $Z_L$  defined in [Figure 1](#).

[2] At  $P_{L(AV)} = 115 \text{ W}$ .

**Table 12. Typical impedance of main device at 1 : 2.5 load**

Measured load-pull data of main device;  $I_{Dq} = 1000 \text{ mA (main)}$ ;  $V_{DS} = 28 \text{ V}$ ; pulsed CW ( $t_p = 100 \mu\text{s}$ ;  $\delta = 10 \%$ ).

f (MHz)	$Z_S$ [1] ( $\Omega$ )	$Z_L$ [1] ( $\Omega$ )	$P_{L(3dB)}$ (W)	$\eta_D$ [2] (%)	$G_p$ [2] (dB)
1805	2.1 – j4.9	2.7 – j1.7	173	58.5	20.5
1845	2.8 – j5.3	2.6 – j1.4	150	60.3	21.0
1880	3.8 – j5.6	2.6 – j1.4	130	60.0	21.0

[1]  $Z_S$  and  $Z_L$  defined in [Figure 1](#).

[2] At  $P_{L(AV)} = 115 \text{ W}$ .

**Table 13. Typical impedance of peak device at 1 : 1 load**

Measured load-pull data of peak device;  $I_{Dq} = 2000 \text{ mA (peak)}$ ;  $V_{DS} = 28 \text{ V}$ ; pulsed CW.

f (MHz)	$Z_S$ [1] ( $\Omega$ )	$Z_L$ [1] ( $\Omega$ )	$P_{L(3dB)}$ (W)	$\eta_D$ [2] (%)	$G_p$ [2] (dB)
1805	1.2 – j4.4	1.3 – j2.8	510	27.5	16.7
1845	1.5 – j4.8	1.3 – j2.6	510	29.0	17.2
1880	1.9 – j5.3	1.3 – j2.3	490	31.0	17.8

[1]  $Z_S$  and  $Z_L$  defined in [Figure 1](#).

[2] At  $P_{L(AV)} = 115 \text{ W}$ .

Table 14. Off-state impedances of peak device

f (MHz)	Z <sub>off</sub> (Ω)
1805	1.5 – j1.2
1845	1.4 – j0.5
1880	1.4 – j0.1

7.4 Test circuit

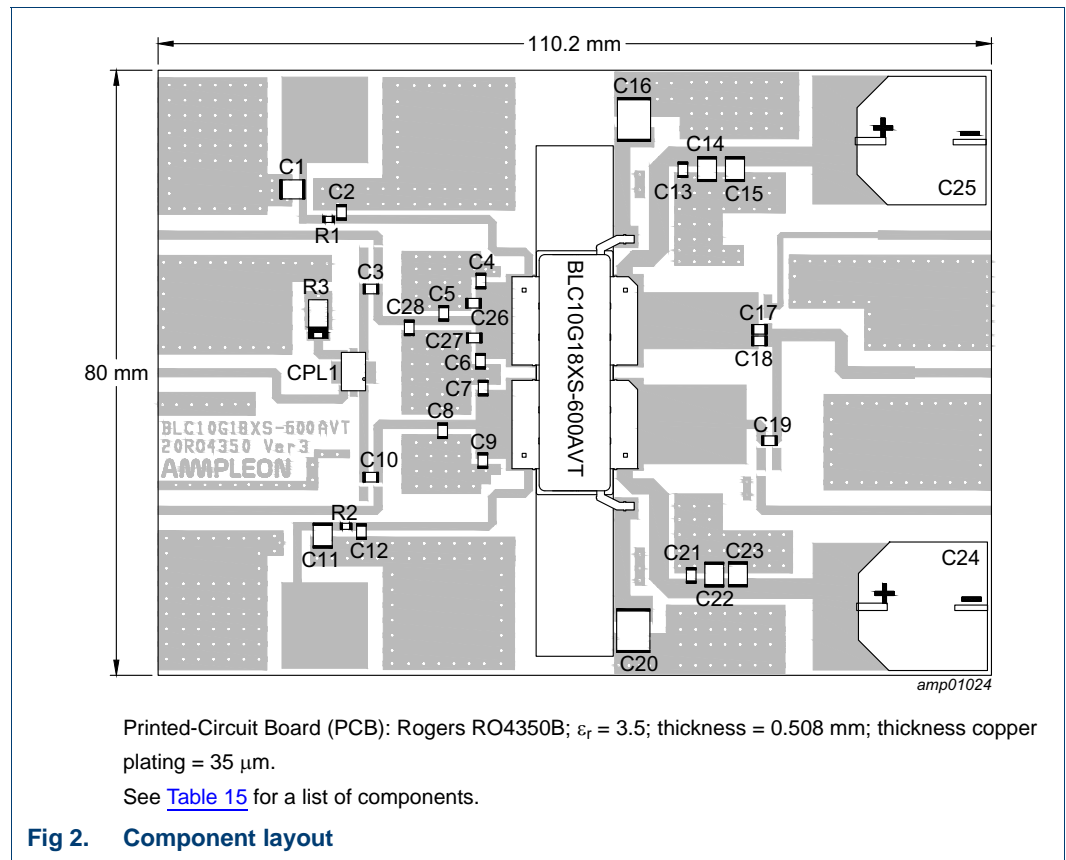

Table 15. List of components

See [Figure 2](#) for component layout.

Component	Description	Value	Remarks
C1, C11, C14, C15, C16, C20, C22, C23	multilayer ceramic chip capacitor	4.7 $\mu\text{F}$ , 50 V	Murata: GRM32ER71H475KA88L, SMD 1210
C2, C3, C10, C12, C13, C19, C21	multilayer ceramic chip capacitor	18 pF	Murata: Hi-Q, GQM21 series
C4, C6	multilayer ceramic chip capacitor	1.8 pF	Murata: Hi-Q, GQM21 series
C5	multilayer ceramic chip capacitor	1.8 pF	Murata: Hi-Q, GQM21 series
C7, C9	multilayer ceramic chip capacitor	2.4 pF	Murata: Hi-Q, GQM21 series
C8	multilayer ceramic chip capacitor	1.1 pF	Murata: Hi-Q, GQM21 series
C17, C18	multilayer ceramic chip capacitor	5.6 pF	Murata: Hi-Q, GQM21 series
C24, C25	electrolytic capacitor	470 $\mu\text{F}$ , 63 V	

Table 15. List of components ...continued  
See Figure 2 for component layout.

Component	Description	Value	Remarks
C26, C27, C28	multilayer ceramic chip capacitor	0.6 pF	Murata: Hi-Q, GQM21 series
R1, R2	resistor	5.1 Ω, 1 %	SMD 0805
R3	resistor	50 Ω, 25 W	Anaren: C16A50Z4
CPL1	hybrid coupler	2 dB, 90°	Anaren: X3C20F1-02S

## 7.5 Graphical data

### 7.5.1 Pulsed CW and CW (VNA sweep)

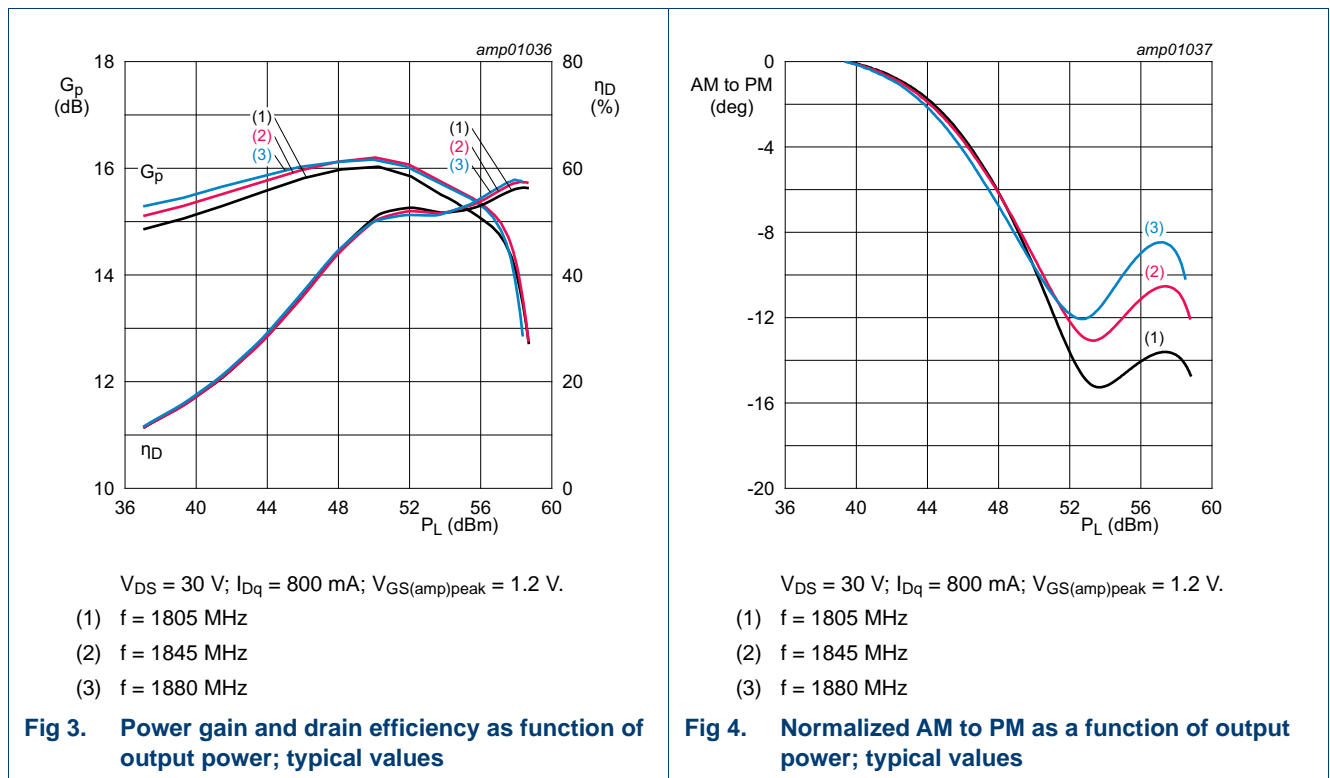

7.5.2 1-Carrier W-CDMA

Test signal: 3GPP test model 1; 64 DPCH (100 % clipping); PAR = 9.9 dB at 0.01 % probability on CCDF.

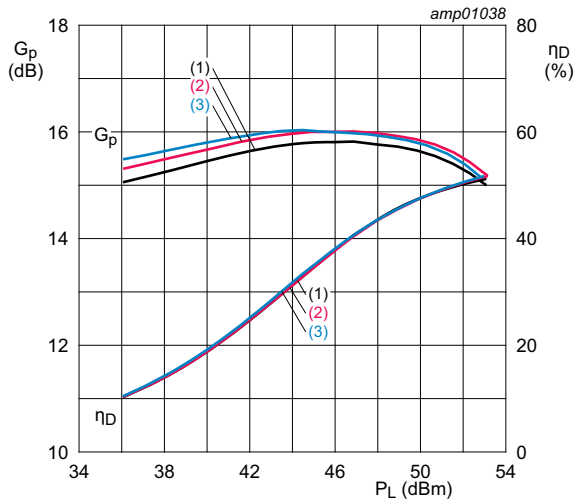

$V_{DS} = 30\text{ V}; I_{Dq} = 800\text{ mA}; V_{GS(amp)peak} = 1.2\text{ V}.$   
 (1)  $f = 1805\text{ MHz}$   
 (2)  $f = 1845\text{ MHz}$   
 (3)  $f = 1880\text{ MHz}$

**Fig 5. Power gain and drain efficiency as function of output power; typical values**

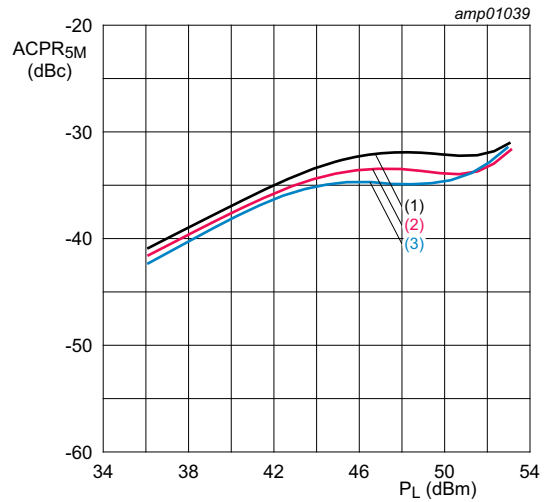

$V_{DS} = 30\text{ V}; I_{Dq} = 800\text{ mA}; V_{GS(amp)peak} = 1.2\text{ V}.$   
 (1)  $f = 1805\text{ MHz}$   
 (2)  $f = 1845\text{ MHz}$   
 (3)  $f = 1880\text{ MHz}$

**Fig 6. Adjacent channel power ratio (5 MHz) as a function of output power; typical values**

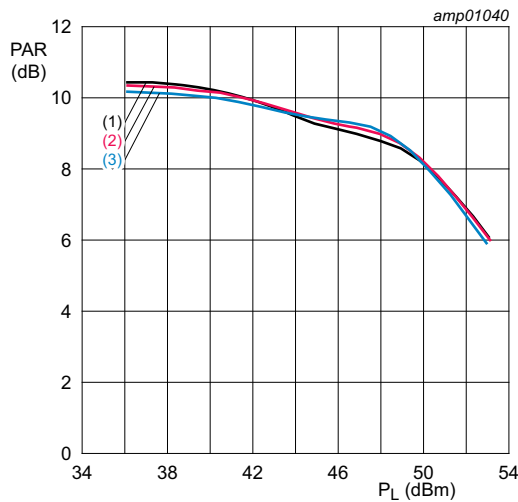

$V_{DS} = 30\text{ V}; I_{Dq} = 800\text{ mA}; V_{GS(amp)peak} = 1.2\text{ V}.$   
 (1)  $f = 1805\text{ MHz}$   
 (2)  $f = 1845\text{ MHz}$   
 (3)  $f = 1880\text{ MHz}$

**Fig 7. Peak-to-average power ratio as a function of output power; typical values**



7.5.3 1-Carrier LTE

Test signal: 1-carrier LTE 10 MHz; PAR = 6.8 dB at 0.01 % probability on CCDF.

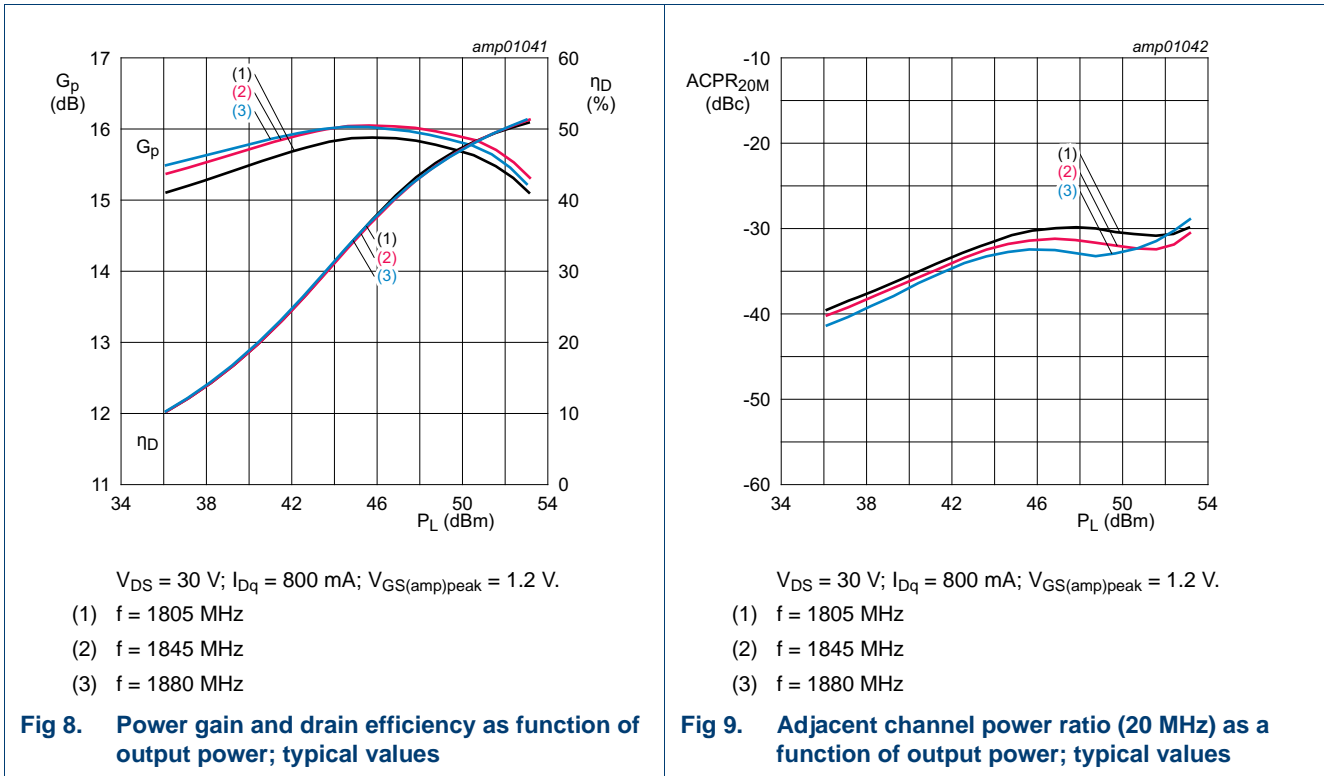

7.5.4 2-Tone VBW

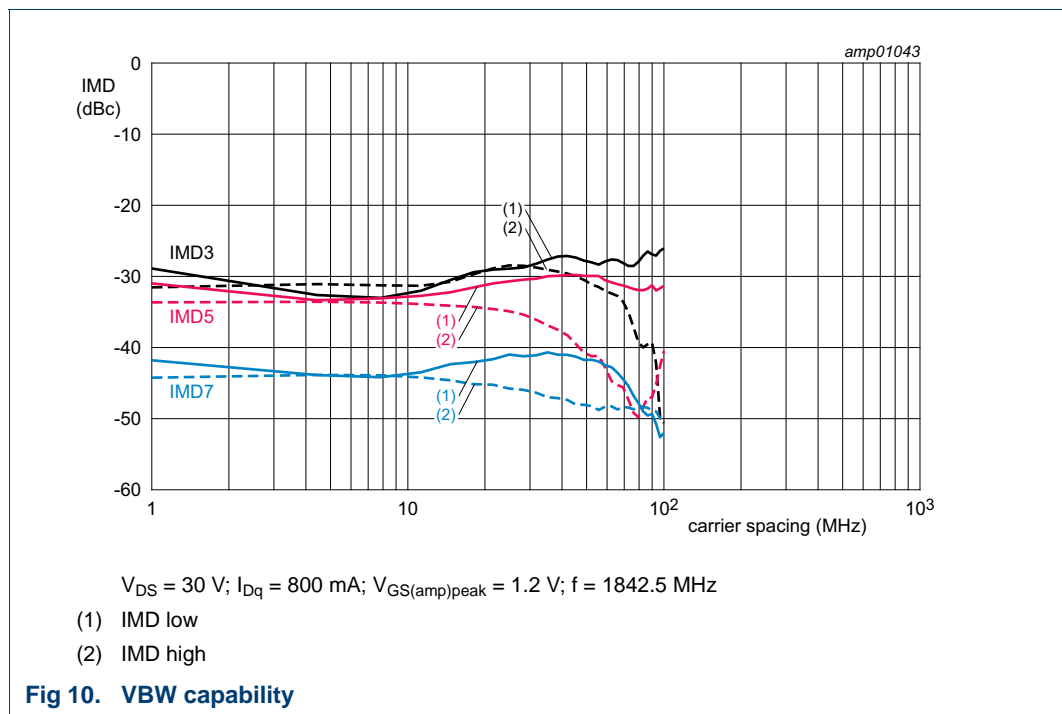

7.5.5 Group delay

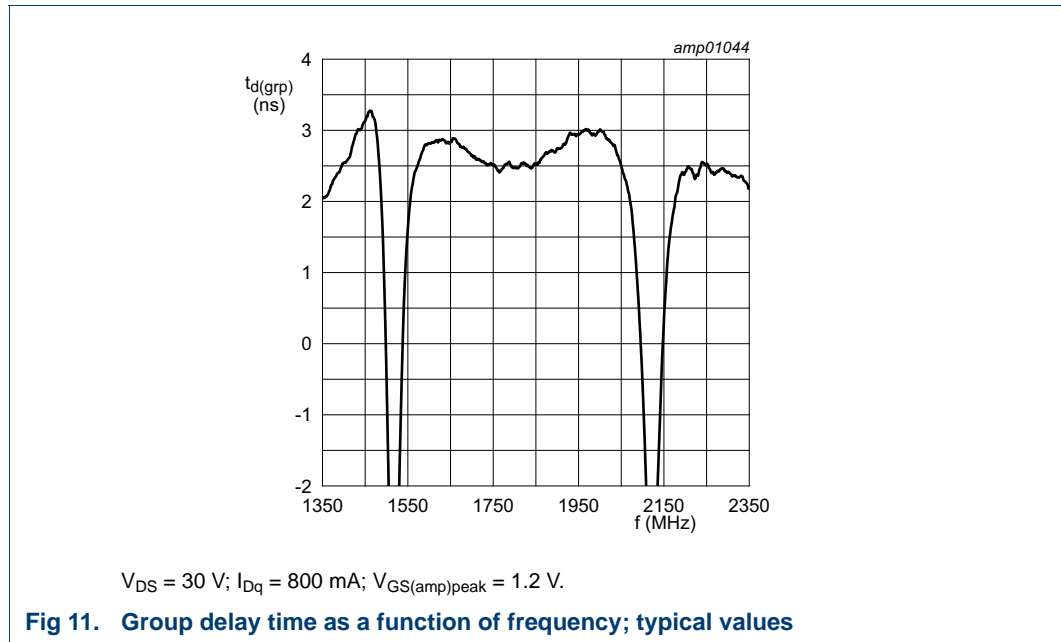

8. Package outline

Air cavity plastic earless flanged package; 6 leads

SOT1258-4

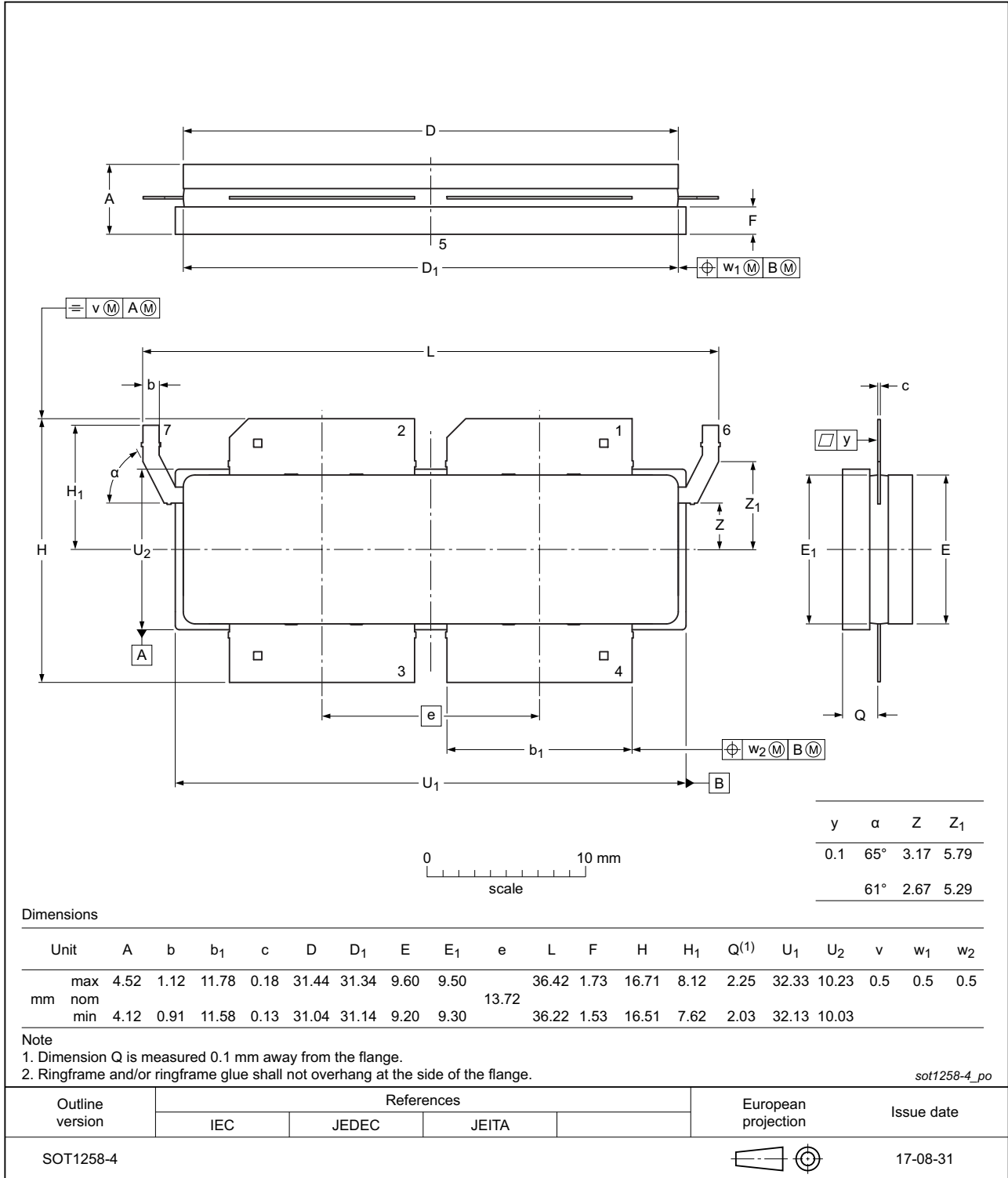

Fig 12. Package outline SOT1258-4

## 9. Handling information

**CAUTION**



This device is sensitive to ElectroStatic Discharge (ESD). Observe precautions for handling electrostatic sensitive devices.

Such precautions are described in the *ANSI/ESD S20.20*, *IEC/ST 61340-5*, *JESD625-A* or equivalent standards.

**Table 16. ESD sensitivity**

ESD model	Class
Charged Device Model (CDM); According to ANSI/ESDA/JEDEC standard JS-002	C3 <a href="#">[1]</a>
Human Body Model (HBM); According to ANSI/ESDA/JEDEC standard JS-001	2 <a href="#">[2]</a>

[1] CDM classification C3 is granted to any part that passes after exposure to an ESD pulse of 1000 V.

[2] HBM classification 2 is granted to any part that passes after exposure to an ESD pulse of 2000 V.

## 10. Abbreviations

**Table 17. Abbreviations**

Acronym	Description
3GPP	3rd Generation Partnership Project
AM	Amplitude Modulation
CCDF	Complementary Cumulative Distribution Function
CW	Continuous Wave
DPCH	Dedicated Physical CHannel
ESD	ElectroStatic Discharge
LDMOS	Laterally Diffused Metal-Oxide Semiconductor
LTE	Long Term Evolution
MTF	Median Time to Failure
OBO	Output Back Off
PAR	Peak-to-Average Ratio
PM	Phase Modulation
RoHS	Restriction of Hazardous Substances
SMD	Surface Mounted Device
VNA	Vector Analyzer Network
VBW	Video BandWidth
VSWR	Voltage Standing Wave Ratio
W-CDMA	Wideband Code Division Multiple Access

## 11. Revision history

**Table 18. Revision history**

Document ID	Release date	Data sheet status	Change notice	Supersedes
BLC10G18XS-600AVT v.1	20200507	Product data sheet	-	-

## 12. Legal information

### 12.1 Data sheet status

Document status <sup>[1][2]</sup>	Product status <sup>[3]</sup>	Definition
Objective [short] data sheet	Development	This document contains data from the objective specification for product development.
Preliminary [short] data sheet	Qualification	This document contains data from the preliminary specification.
Product [short] data sheet	Production	This document contains the product specification.

[1] Please consult the most recently issued document before initiating or completing a design.

[2] The term 'short data sheet' is explained in section "Definitions".

[3] The product status of device(s) described in this document may have changed since this document was published and may differ in case of multiple devices. The latest product status information is available on the Internet at URL <http://www.ampleon.com>.

### 12.2 Definitions

**Draft** — The document is a draft version only. The content is still under internal review and subject to formal approval, which may result in modifications or additions. Ampleon does not give any representations or warranties as to the accuracy or completeness of information included herein and shall have no liability for the consequences of use of such information.

**Short data sheet** — A short data sheet is an extract from a full data sheet with the same product type number(s) and title. A short data sheet is intended for quick reference only and should not be relied upon to contain detailed and full information. For detailed and full information see the relevant full data sheet, which is available on request via the local Ampleon sales office. In case of any inconsistency or conflict with the short data sheet, the full data sheet shall prevail.

**Product specification** — The information and data provided in a Product data sheet shall define the specification of the product as agreed between Ampleon and its customer, unless Ampleon and customer have explicitly agreed otherwise in writing. In no event however, shall an agreement be valid in which the Ampleon product is deemed to offer functions and qualities beyond those described in the Product data sheet.

### 12.3 Disclaimers

**Maturity** — The information in this document can only be regarded as final once the relevant product(s) has passed the Release Gate in Ampleon's release process. Prior to such release this document should be regarded as a draft version.

**Limited warranty and liability** — Information in this document is believed to be accurate and reliable. However, Ampleon does not give any representations or warranties, expressed or implied, as to the accuracy or completeness of such information and shall have no liability for the consequences of use of such information. Ampleon takes no responsibility for the content in this document if provided by an information source outside of Ampleon.

In no event shall Ampleon be liable for any indirect, incidental, punitive, special or consequential damages (including - without limitation - lost profits, lost savings, business interruption, costs related to the removal or replacement of any products or rework charges) whether or not such damages are based on tort (including negligence), warranty, breach of contract or any other legal theory.

Notwithstanding any damages that customer might incur for any reason whatsoever, Ampleon's aggregate and cumulative liability towards customer for the products described herein shall be limited in accordance with the *Terms and conditions of commercial sale* of Ampleon.

**Right to make changes** — Ampleon reserves the right to make changes to information published in this document, including without limitation specifications and product descriptions, at any time and without notice. This document supersedes and replaces all information supplied prior to the publication hereof.

**Suitability for use** — Ampleon products are not designed, authorized or warranted to be suitable for use in life support, life-critical or safety-critical systems or equipment, nor in applications where failure or malfunction of an Ampleon product can reasonably be expected to result in personal injury, death or severe property or environmental damage. Ampleon and its suppliers accept no liability for inclusion and/or use of Ampleon products in such equipment or applications and therefore such inclusion and/or use is at the customer's own risk.

**Applications** — Applications that are described herein for any of these products are for illustrative purposes only. Ampleon makes no representation or warranty that such applications will be suitable for the specified use without further testing or modification.

Customers are responsible for the design and operation of their applications and products using Ampleon products, and Ampleon accepts no liability for any assistance with applications or customer product design. It is customer's sole responsibility to determine whether the Ampleon product is suitable and fit for the customer's applications and products planned, as well as for the planned application and use of customer's third party customer(s). Customers should provide appropriate design and operating safeguards to minimize the risks associated with their applications and products.

Ampleon does not accept any liability related to any default, damage, costs or problem which is based on any weakness or default in the customer's applications or products, or the application or use by customer's third party customer(s). Customer is responsible for doing all necessary testing for the customer's applications and products using Ampleon products in order to avoid a default of the applications and the products or of the application or use by customer's third party customer(s). Ampleon does not accept any liability in this respect.

**Limiting values** — Stress above one or more limiting values (as defined in the Absolute Maximum Ratings System of IEC 60134) will cause permanent damage to the device. Limiting values are stress ratings only and (proper) operation of the device at these or any other conditions above those given in the Recommended operating conditions section (if present) or the Characteristics sections of this document is not warranted. Constant or repeated exposure to limiting values will permanently and irreversibly affect the quality and reliability of the device.

**Terms and conditions of commercial sale** — Ampleon products are sold subject to the general terms and conditions of commercial sale, as published at <http://www.ampleon.com/terms>, unless otherwise agreed in a valid written individual agreement. In case an individual agreement is concluded only the terms and conditions of the respective agreement shall apply. Ampleon hereby expressly objects to applying the customer's general terms and conditions with regard to the purchase of Ampleon products by customer.

**No offer to sell or license** — Nothing in this document may be interpreted or construed as an offer to sell products that is open for acceptance or the grant, conveyance or implication of any license under any copyrights, patents or other industrial or intellectual property rights.

**Export control** — This document as well as the item(s) described herein may be subject to export control regulations. Export might require a prior authorization from competent authorities.

**Non-automotive qualified products** — Unless this data sheet expressly states that this specific Ampleon product is automotive qualified, the product is not suitable for automotive use. It is neither qualified nor tested in accordance with automotive testing or application requirements. Ampleon accepts no liability for inclusion and/or use of non-automotive qualified products in automotive equipment or applications.

In the event that customer uses the product for design-in and use in automotive applications to automotive specifications and standards, customer (a) shall use the product without Ampleon's warranty of the product for such

automotive applications, use and specifications, and (b) whenever customer uses the product for automotive applications beyond Ampleon's specifications such use shall be solely at customer's own risk, and (c) customer fully indemnifies Ampleon for any liability, damages or failed product claims resulting from customer design and use of the product for automotive applications beyond Ampleon's standard warranty and Ampleon's product specifications.

**Translations** — A non-English (translated) version of a document is for reference only. The English version shall prevail in case of any discrepancy between the translated and English versions.

## 12.4 Trademarks

Notice: All referenced brands, product names, service names and trademarks are the property of their respective owners.

## 13. Contact information

---

For more information, please visit: <http://www.ampleon.com>

For sales office addresses, please visit: <http://www.ampleon.com/sales>

14. Contents

1 **Product profile** . . . . . 1

1.1 General description . . . . . 1

1.2 Features and benefits . . . . . 1

1.3 Applications . . . . . 1

2 **Pinning information** . . . . . 2

3 **Ordering information** . . . . . 2

4 **Limiting values** . . . . . 2

5 **Thermal characteristics** . . . . . 2

6 **Characteristics** . . . . . 3

7 **Test information** . . . . . 4

7.1 Ruggedness in Doherty operation . . . . . 4

7.2 Impedance information . . . . . 4

7.3 Recommended impedances for Doherty design 5

7.4 Test circuit . . . . . 6

7.5 Graphical data . . . . . 7

7.5.1 Pulsed CW and CW (VNA sweep) . . . . . 7

7.5.2 1-Carrier W-CDMA . . . . . 8

7.5.3 1-Carrier LTE . . . . . 9

7.5.4 2-Tone VBW . . . . . 9

7.5.5 Group delay . . . . . 10

8 **Package outline** . . . . . 11

9 **Handling information** . . . . . 12

10 **Abbreviations** . . . . . 12

11 **Revision history** . . . . . 12

12 **Legal information** . . . . . 13

12.1 Data sheet status . . . . . 13

12.2 Definitions . . . . . 13

12.3 Disclaimers . . . . . 13

12.4 Trademarks . . . . . 14

13 **Contact information** . . . . . 14

14 **Contents** . . . . . 15

Please be aware that important notices concerning this document and the product(s) described herein, have been included in section 'Legal information'.

© Ampleon Netherlands B.V. 2020. All rights reserved.

For more information, please visit: <http://www.ampleon.com>  
 For sales office addresses, please visit: <http://www.ampleon.com/sales>

Date of release: 7 May 2020

Document identifier: BLC10G18XS-600AVT